

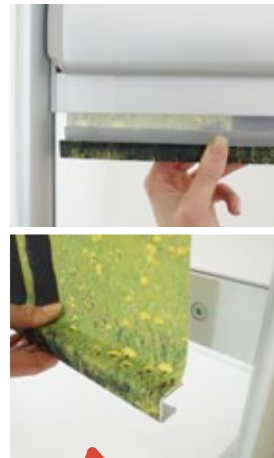

**✓ regolabile e fissabile
stufenlos ausziehen und feststellen
stagelessly adjustable in length**



incollare il banner sulla barra di appoggio; appendere il supporto alla struttura. il banner può essere esposto alla lunghezza desiderata grazie al sistema di bloccaggio.
banner auf die schienenhalterung kleben, halterung dann einfach einhängen. das banner kann wie ein rollo auf beliebige länge ausgezogen und arrettiert werden.
mount the banner to the rail support, then simply hang to the bottom cross bar. banner can be extended and locked in place like a roller blind



wallup[®] soistes

MADE IN GERMANY controlled by KD

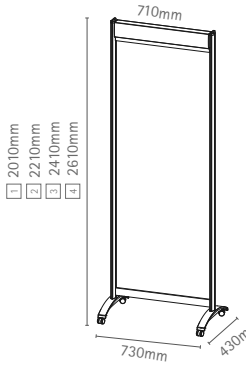

- SOWU2010710
- SOWU2210710
- SOWU2410710
- SOWU2610710

struttura mobile soistes in alluminio anodizzato color argento, connettori in metallo pressofuso, con ruote e sistema wallup.
mobile soistes struktur aus silber eloxiertem aluminium, silber matt verchromten metalldruckguss, leichtlaufrollen und wallup system
mobile soistes structure in silver anodized aluminium, silver matt plated die cast metal, castors and wallup system

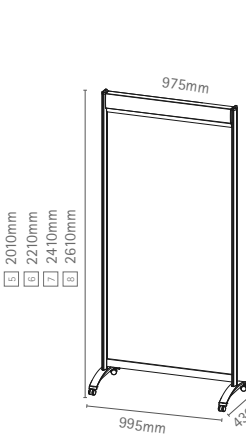

- SOWU2010975
- SOWU2210975
- SOWU2410975
- SOWU2610975

struttura mobile soistes in alluminio anodizzato color argento, connettori in metallo pressofuso, con ruote e sistema wallup.
mobile soistes struktur aus silber eloxiertem aluminium, silber matt verchromten metalldruckguss, leichtlaufrollen und wallup system
mobile soistes structure in silver anodized aluminium, silver matt plated die cast metal, castors and wallup system

IT il nostro sistema modulare soistes, usato in combinazione con wallup, si trasforma in un roll up di prima categoria. dopo l'inserimento del banner e il montaggio della struttura, il telo si svolge e si riavvolge facilmente e in qualsiasi momento. in questo modo il sistema è molto facile da utilizzare e veloce da installare. grazie alla modularità di soistes, wallup può sempre essere modificato ed integrato con nuovi moduli o accessori: combinando vari elementi si possono realizzare delle pareti divisorie, oppure dei veri e propri espositori per informazioni e cataloghi grazie ai ripiani e ai portadepliant della linea soistes.

DE unser einrichtungssystem soistes wird in der kombination mit wallup zu einem mobilen rollup der extra klasse. nach der bannermontage lässt sich das banner jederzeit leicht und schnell ausziehen und einhängen. dabei ist das ganze system einfach und in kurzer zeit aufgestellt. dank der modularität von soistes, ist wallup soistes jederzeit erweiter- und ausbaubar: aus mehreren elementen werden stellwände und mit den passenden ablagen und fachböden entsteht ein perfektes system für die info- und produktpräsentation.

EN our shop fitting system soistes becomes a first class mobile rollup in combination with wallup. after mounting, the banner can be easily extended and attached. the complete system sets up in a short time. thanks to the modular soistes system the wallup soistes can be added to at anytime: more elements can make movable walls while, with the matching trays and shelves, you can build a perfect information and product presentation system.

wallup soistes

n° articolo artikelnr. product nr.		
1	SOWU2010710 *	wallup soistes 2010x710mm, 1pc
2	SOWU2210710 *	wallup soistes 2210x710mm, 1pc
3	SOWU2410710 *	wallup soistes 2410x710mm, 1pc
4	SOWU2610710 *	wallup soistes 2410x710mm, 1pc
5	SOWU2010975 *	wallup soistes 2010x975mm, 1pc
6	SOWU2210975 *	wallup soistes 2210x975mm, 1pc
7	SOWU2410975 *	wallup soistes 2410x975mm, 1pc
8	SOWU2610975 *	wallup soistes 2410x975mm, 1pc

* in vendita da febbraio 2012 | auslieferung ab februar 2012 | on sale from february 2012

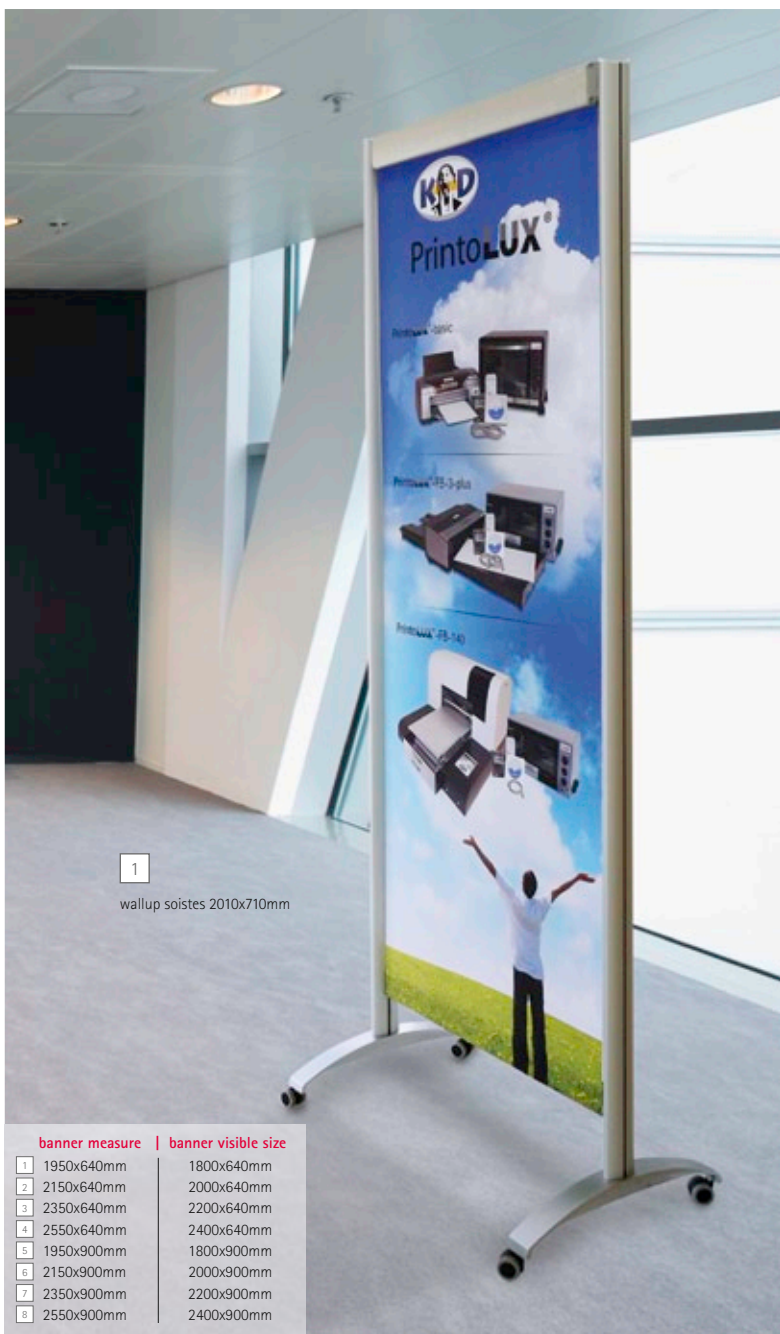

1
wallup soistes 2010x710mm

banner measure | banner visible size

1	1950x640mm	1800x640mm
2	2150x640mm	2000x640mm
3	2350x640mm	2200x640mm
4	2550x640mm	2400x640mm
5	1950x900mm	1800x900mm
6	2150x900mm	2000x900mm
7	2350x900mm	2200x900mm
8	2550x900mm	2400x900mm



struttura modulare facile e veloce da montare
modulare bauweise schnell und einfach aufgestellt
modular design: sets up quickly and easily

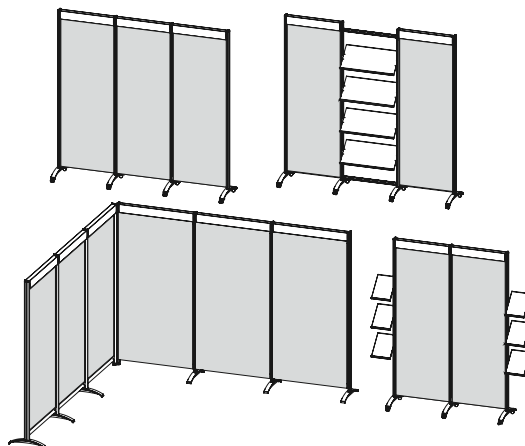
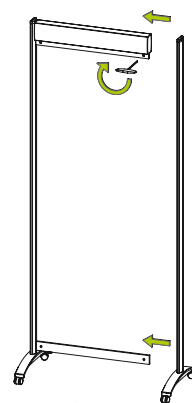

mobile, flessibile, modulare
mobil, flexibel, erweiterbar
mobile, flexible, extendable

wallup soistes module

n° articolo | artikelnr. | product nr.

9	SOWU2010710M *	wallup soistes module 2010x710mm, 1pc
10	SOWU2210710M *	wallup soistes module 2210x710mm, 1pc
11	SOWU2410710M *	wallup soistes module 2410x710mm, 1pc
12	SOWU2610710M *	wallup soistes module 2610x710mm, 1pc
13	SOWU2010975M *	wallup soistes module 2010x975mm, 1pc
14	SOWU2210975M *	wallup soistes module 2210x975mm, 1pc
15	SOWU2410975M *	wallup soistes module 2410x975mm, 1pc
16	SOWU2610975M *	wallup soistes module 2610x975mm, 1pc

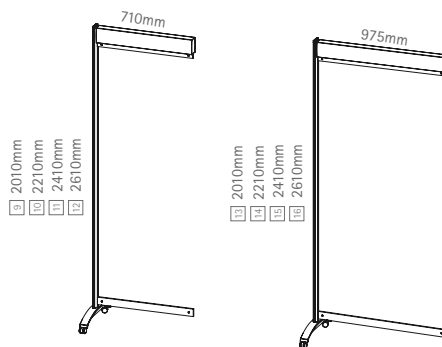

* in vendita da febbraio 2012 | auslieferung ab februar 2012 | on sale from february 2012